

# 8" x 12" Steel Skirt Manhole (3 Bolt Lid)

## Specifications

8"x12" Cast Iron Curb Box  
3 Bolt - Water Resistant  
Steel Skirt  
H-20 Load Rated  
Weight 14.4 lbs

Item#: MM8X12M3

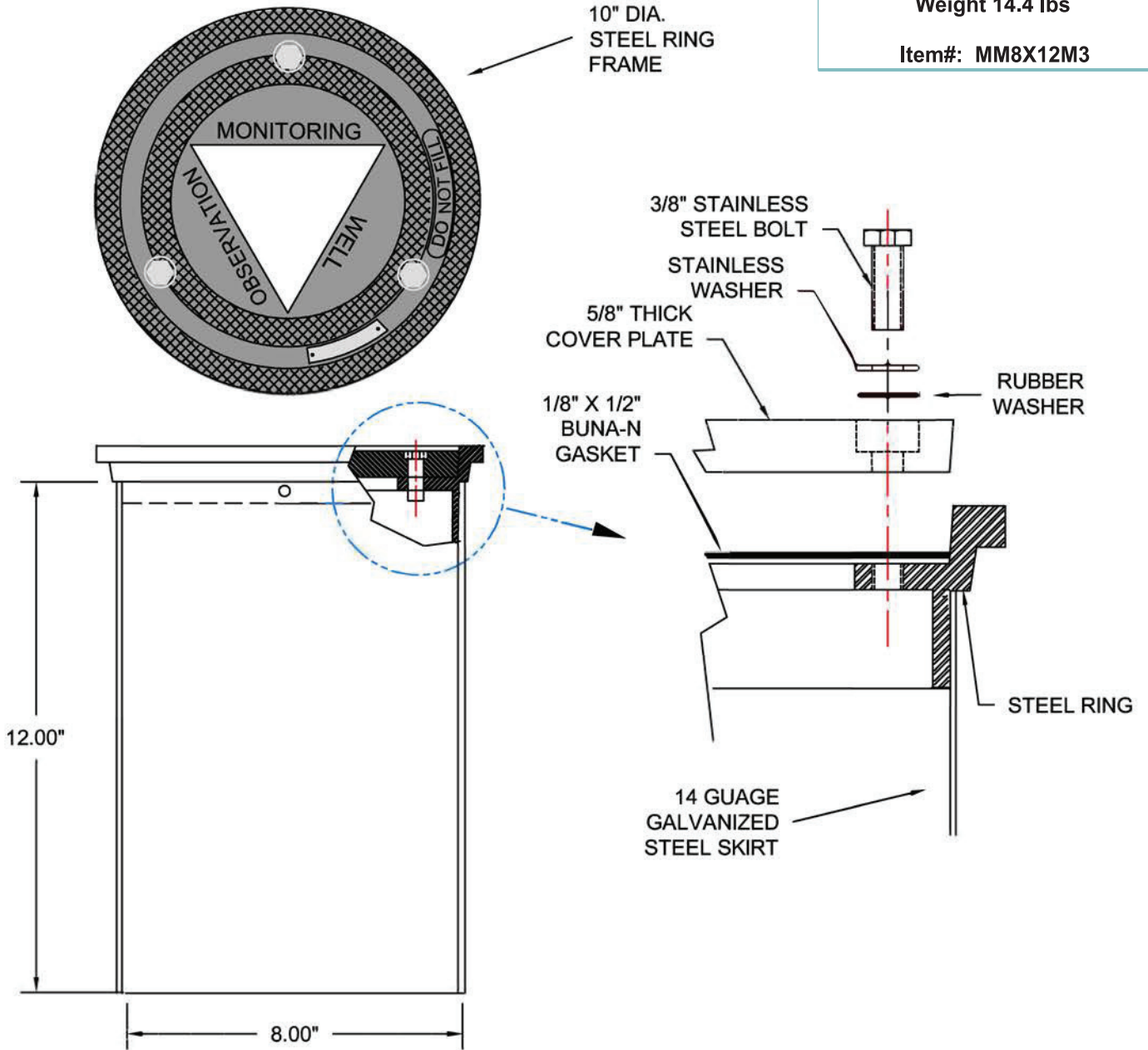

ECT Manufacturing, Inc.  
11 Black Forest Rd | Hamilton, NJ | 08691  
t. 609.631.8939 | 888.240.4328 | f. 609.631.0993  
www.ectmfg.com